



# LED Accessory Liner

## Installation Manual

Genuine Part Number H4510VC200  
 Applicable Model WRX 2022MY-

Thank you for purchasing the Subaru Genuine LED Accessory Liner.  
 This manual describes the procedure to install the LED Accessory Liner on the SUBARU WRX. Be sure to read this manual before installing this product and follow the instructions described below.







- Do not modify this product before installing it on the vehicle.
- Note that you may be held responsible for any malfunctions that occur due to not following these precautions.

<Make sure to give the separate instruction manual to the customer. >

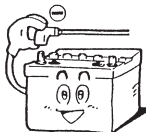
### Installation Caution Instructions and Preparation Work

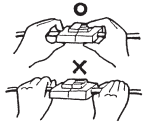
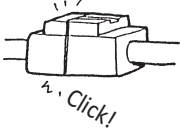
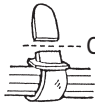
 **NOTE** Ignore this symbol and making a mistake during installation may cause injury. It indicates content that may lead to physical damage to the product.

- Before beginning the work, take note of the caution instructions below to safely and correctly install the parts. For details of removing the parts, see the Service Manual.
- Always check the latest Service Manual, and if there are any discrepancies due to revisions, follow the instructions in the Service Manual.
- For vehicles equipped with airbags, do not touch the airbag harness (yellow tape). Take extra care as touching or damaging the harness may cause the airbag to malfunction.
- You may be held responsible for any faults that occur due to not following the notes in this manual.
- To perform the installation work properly and safely, comply with the following notes.

 <b>CAUTION</b>		
<ul style="list-style-type: none"> <li>● Make sure the ⊖ terminal on the battery is disconnected while doing the wiring work. Not doing so may cause an electric shock or injury due to an electrical short.</li> </ul> 	<ul style="list-style-type: none"> <li>● Check that the electrical equipment on the vehicle functions correctly. Also take a note of the memory of the radio and other electrical equipment. This prevents issues when checking re-installation after the parts have been installed.</li> </ul> 	<ul style="list-style-type: none"> <li>● When tightening nuts and bolts, use a tool that matches the dimensions and follow the specified torque in the tightening torque instructions. If you do not do so, there is the danger of damaging the nuts and bolts, and them coming off by not securing them properly.</li> </ul> 
<ul style="list-style-type: none"> <li>● When removing the vehicle connectors, disconnect the lock while holding the connector and do not pull the lead wires. This will prevent the lead wires from breaking.</li> </ul> 	<ul style="list-style-type: none"> <li>● Connect the terminals and connectors securely. This prevents poor connections.</li> </ul> 	<ul style="list-style-type: none"> <li>● When routing the harness (wiring), use a clamp to secure the wire harnesses to prevent the wires from being loose. This prevents abnormal noises and the harnesses from getting caught.</li> </ul> 
<ul style="list-style-type: none"> <li>● When installing the parts or removed finishers, be careful not to pull or get the back of the harness caught. This will prevent the wires from breaking and short-circuits.</li> </ul> 	<ul style="list-style-type: none"> <li>● Do not strongly pull the vehicle wire harness. This prevents the connector from being disconnected, and wire breakage and damage.</li> </ul> 	<ul style="list-style-type: none"> <li>● After routing the harnesses, check that the installed parts function correctly before reinstalling the removed parts. This prevents mis-wiring.</li> </ul> 

### CAUTION

Follow the Service Manual for the procedure to disconnect and connect battery terminals and read the precautions when performing the work.  
 Also perform the reconfiguration work as per the Service Manual after installation.

1. When removing the vehicle parts, be careful not to scratch or damage them.
2. When paying the wiring, be careful not to damage the harnesses on the edge of the vehicle's body panel.

## Installation Overview

- This Installation Manual is for installing the LED Accessory Liner on the SUBARU WRX.
- Perform the installation work with the Front Bumper removed from the vehicle.

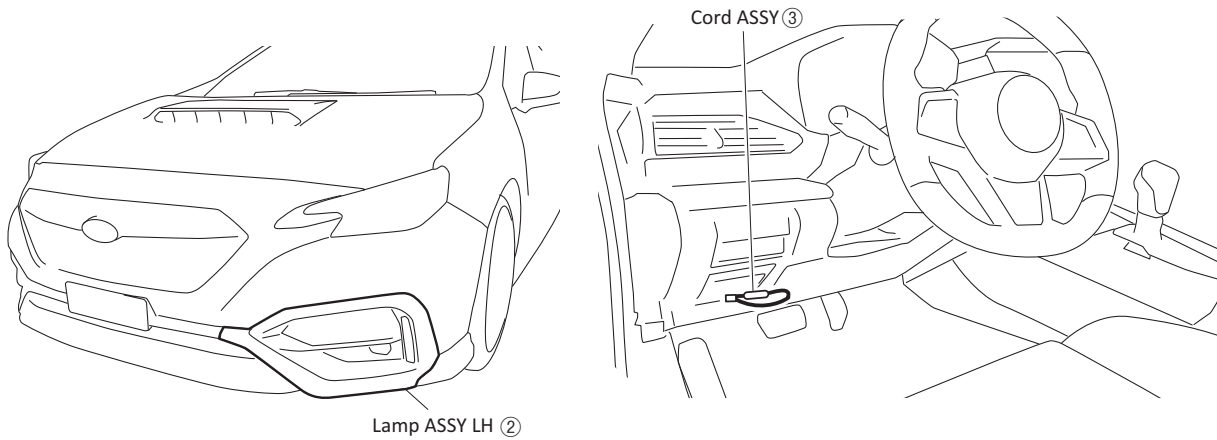

## Component Parts (Make sure to check the component parts before starting the work.)

No.	Part Name	Quantity
①	Lamp ASSY RH	1
②	Lamp ASSY LH	1
③	Cord ASSY	1
④	Banding Band	3
⑤	Urethane Foam	2

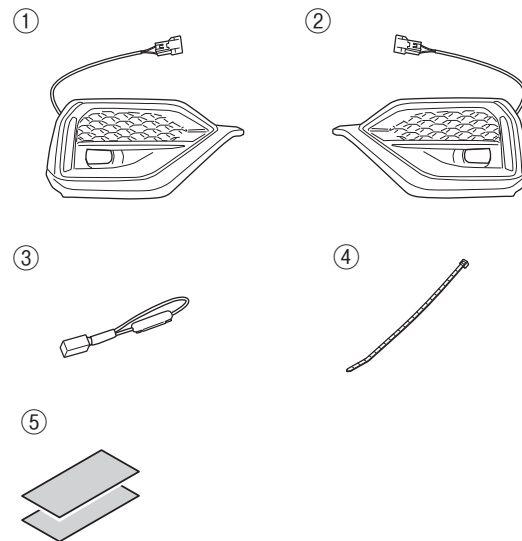

## Tools Required

- Socket Wrench (10 mm)
- Scissors
- Clip Remover
- Protective Tape
- Diagonal Pliers

## Installation Procedure

Figure 1

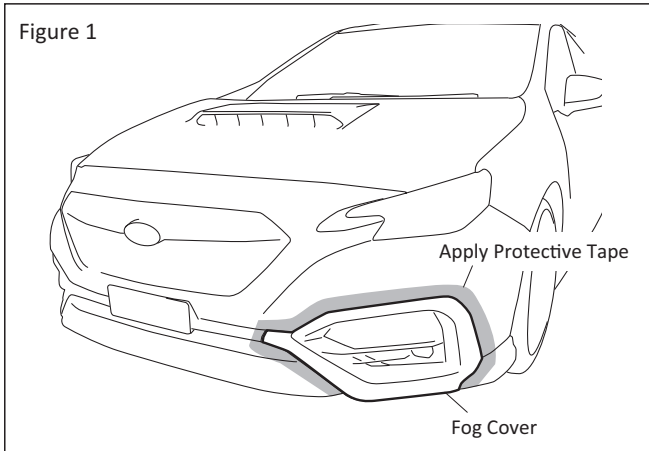

Figure 2

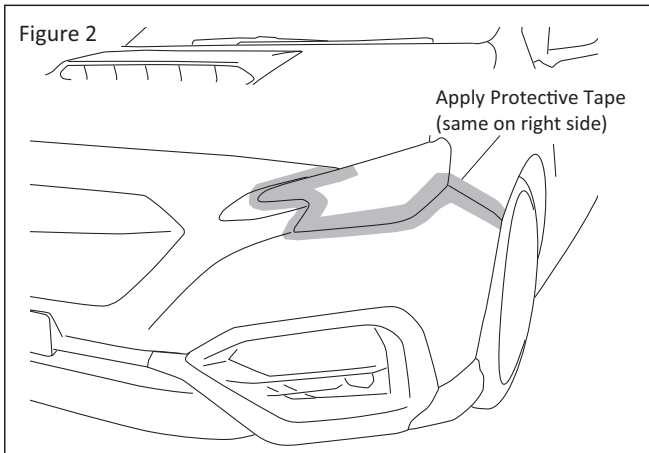

Figure 3

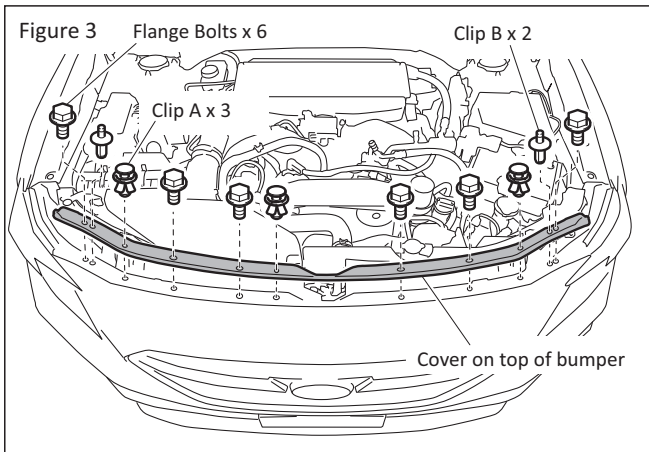
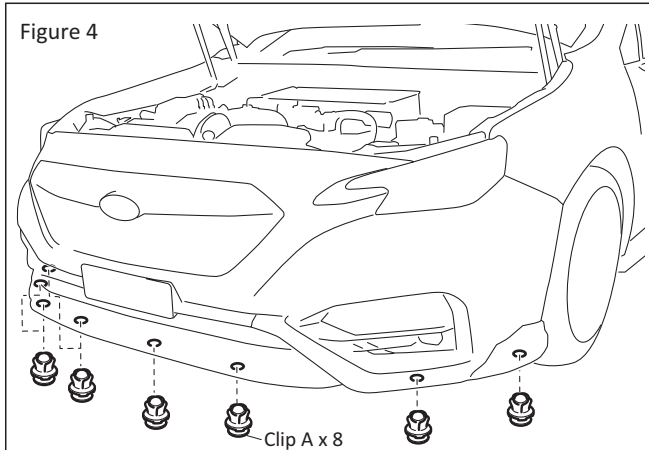

Figure 4



### 1. Before beginning the installation work

- Move the driver's seat as far back as possible in advance to perform the cabin wiring work.
- Open the hood and disconnect the minus terminal on the battery.

#### ⚠ CAUTION

When you disconnect the battery terminal, radio channels and other items saved in memory will be deleted, so make a note or backup of them before you disconnect the cable.

- Apply Protective Tape around the Fog Cover.
- Prepare a storage box to put the parts in so that you do not lose the removed parts.

### 2. Installing the LED Accessory Liner

- Although this procedure shows the work for the left side of the vehicle, follow the same procedure for the right side.

#### Removing the Front Bumper

- 1) Apply Protective Tape to the shaded area shown in the figure.
- 2) Remove the Flange Bolt and Clip on the cover at the top of the bumper.  
(Bolt: 6 places; Clip A: 3 places; Clip B: 2 places)
- 3) Remove the Clip at the bottom of the bumper.  
(Clip A: 8 places)

Figure 5

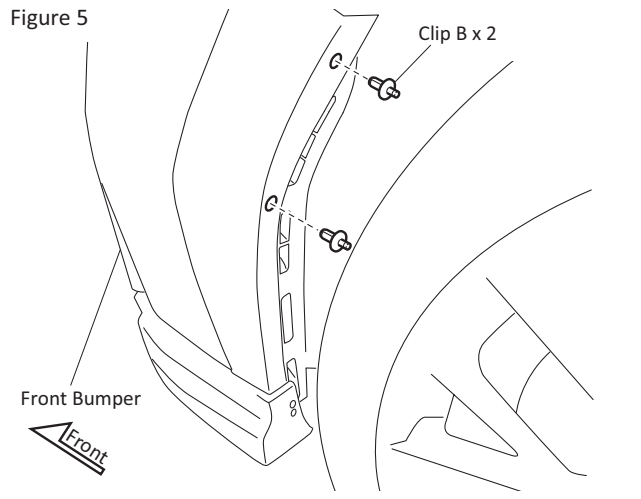

- 4) Remove the Clip on the bumper fender.  
(Clip B: 2 places)

Figure 6

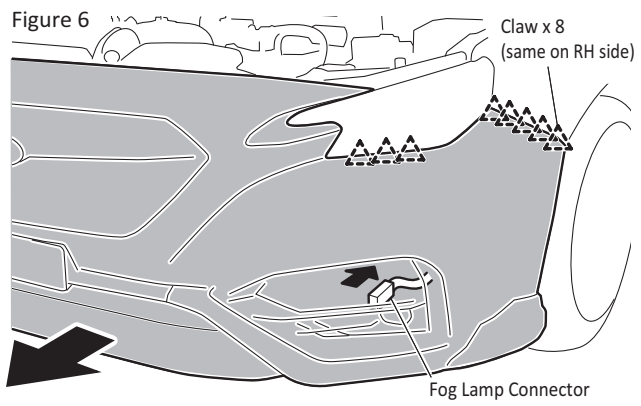

- 5) Disengage the Claws (8 places) on the top of the Front Bumper and then remove the Front Bumper.
- 6) Disconnect the connector inside the Fog Lamp.

Figure 7

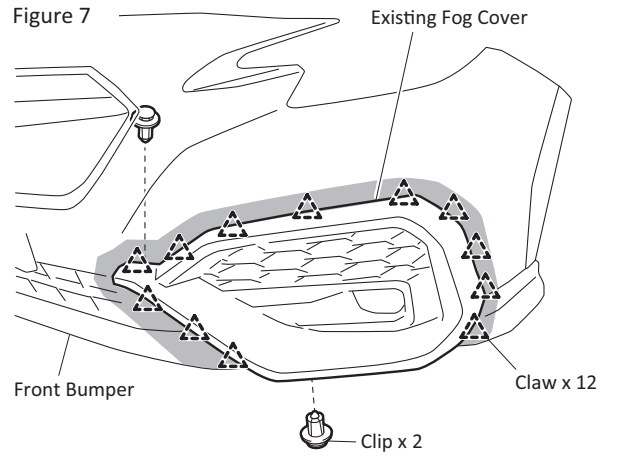

### Removing the Existing Fog Cover

- Although this procedure shows the work for the left side of the vehicle, follow the same procedure for the right side.

- 1) Disengage the Clips and Claws on the Fog Cover, and then remove the Existing Fog Cover from the Front Bumper.  
(Clips: 2 places; Claws: 12 places)

#### **⚠ CAUTION**

- The removed Clips will be reused. Store them in a safe place so that you do not lose them.
- Return the Fog Cover that you removed to the customer.

Figure 8

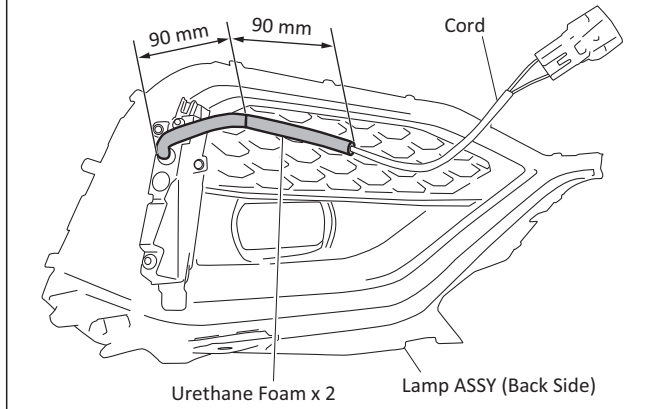

## Installing the Lamp ASSY

- Although this procedure shows the work for the left side of the vehicle, follow the same procedure for the right side.

1) Wrap Urethane Foam around the Lamp ASSY cord.

### ⚠ CAUTION

Wrap the Urethane Foam (2 pcs) from the base of the lamp cord.

1st piece

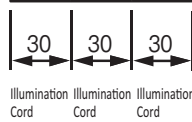
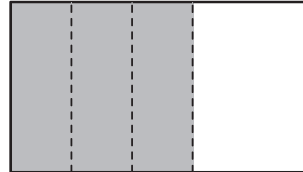

2nd piece

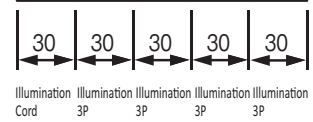
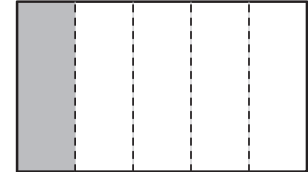
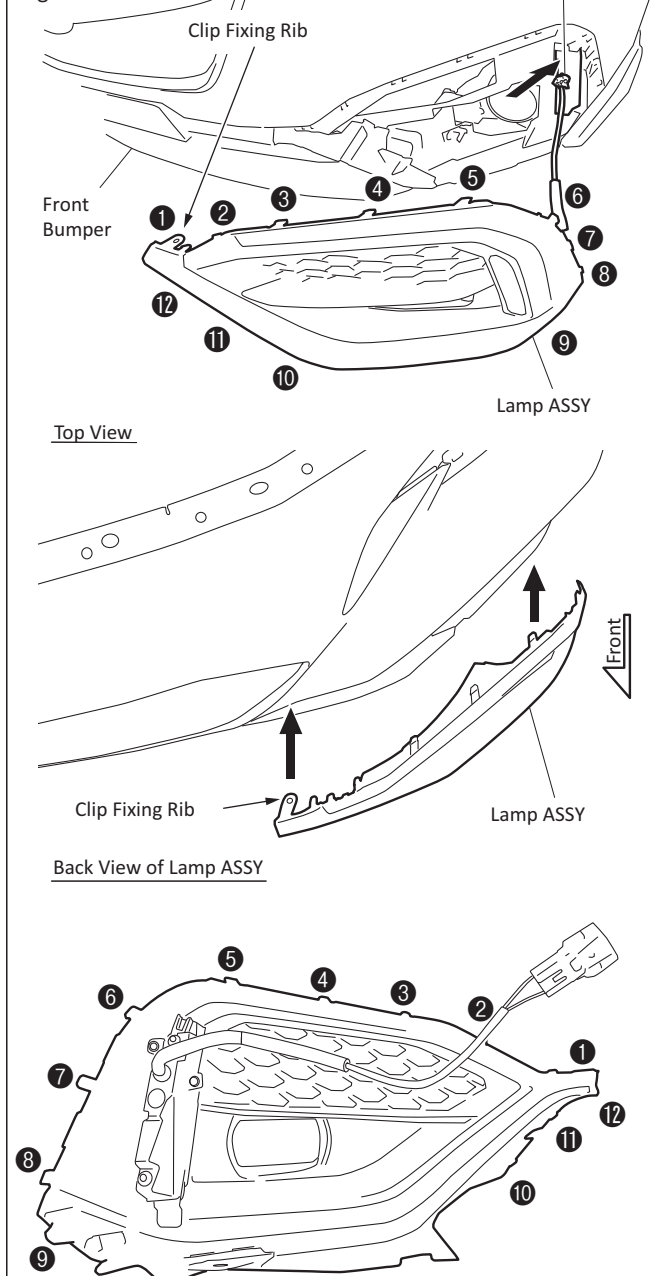

Figure 9



2) Pass the Lamp ASSY 3P connector through the hole in the Front Bumper and then connect it to the Lamp ASSY.

- ※ To install the Lamp ASSY, insert the Claws following the steps below parallel to the direction the vehicle travels.

(a) Insert the Clip Fixing Rib to secure the Clip first and then insert Claw 7 about 5 mm.

### ⚠ CAUTION

Do not engage the Claw yet. If you engage the Claw, you will not be able to correctly install Claws 1 to 5 and Claws 10 to 12.

(b) Insert the Claws in order of Claw 1, Claw 2, Claw 3, Claw 12, Claw 11, and Claw 10 and engage the inside Claws.

(c) Insert the Claws in order of Claw 4, Claw 5, Claw 6, Claw 7, Claw 8, and Claw 9, and engage the outside Claws.

### ⚠ CAUTION

When inserting the Lamp ASSY Claws, assemble them parallel to the direction the vehicle travels.

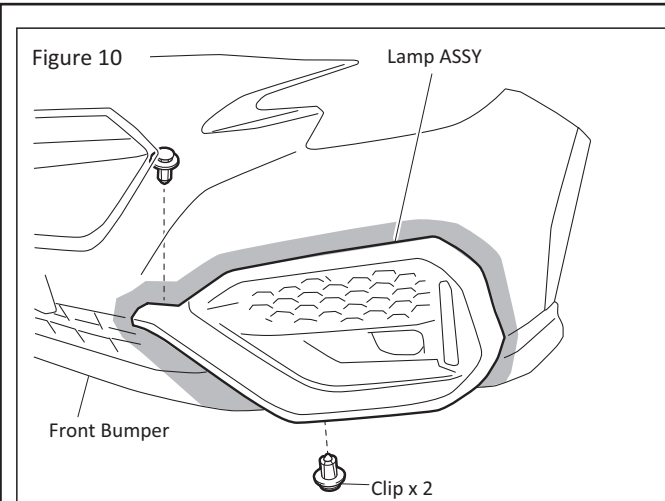

- 3) Attach the Clips to the Lamp Assy.  
(Clip: 2 places)

**CAUTION**

Insert the Lamp Assy making sure that the outside of the Lamp Assy does not ride up onto the guide rib on the Front Bumper and confirm that all 12 Claws are engaged.

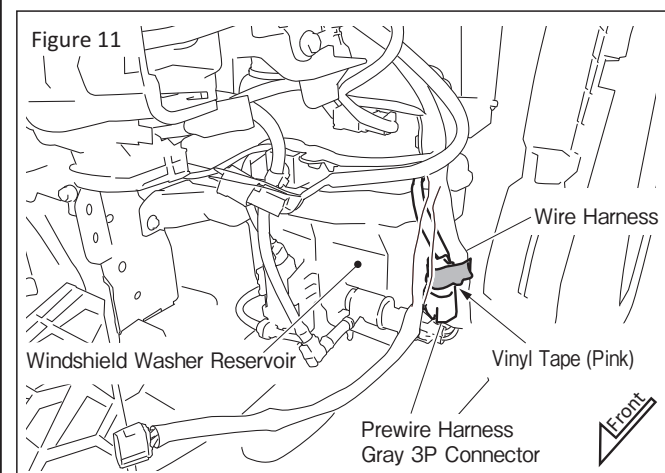

**Connecting the Wire Harness: Left Side**

- 1) Peel off the Vinyl Tape (Pink) wrapped around the Wire Harness and pull out the Prewire Harness.
- 2) Detach the Dummy Connector from the gray 3P connector on the Prewire Harness.  
(Return the Dummy Connector that you removed to the customer.)

**CAUTION**

If you directly pull the Wire Harness without peeling off the Vinyl Tape (Pink), you risk damaging the Wire Harness.

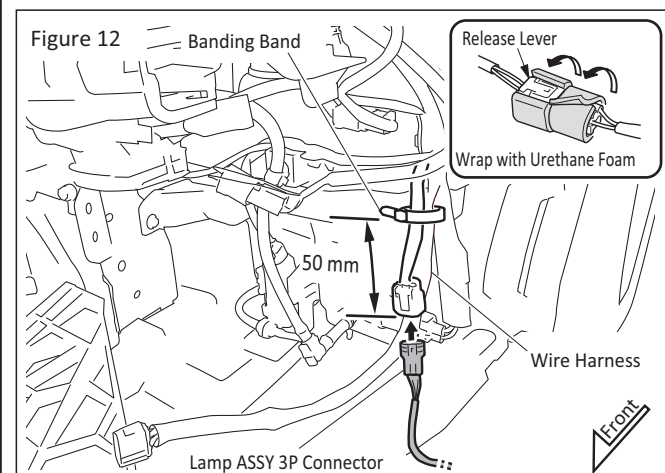

- 3) Secure the Prewire Harness to the Wire Harness using a Banding Band.
- 4) Connect the Lamp Assy 3P connector to the Gray 3P Connector.

**CAUTION**

Wrap Urethane Foam around the connector ensuring that you can see the Release Lever.

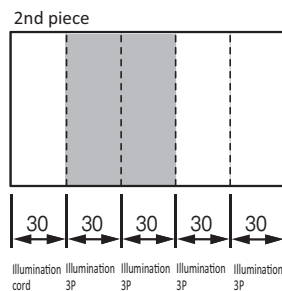
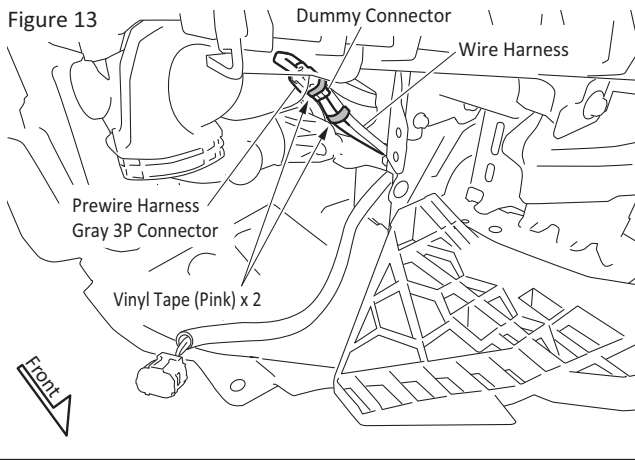

Figure 13



### Connecting the Wire Harness: Right Side

- 1) Peel off the Vinyl Tape (Pink) wrapped around the Wire Harness and pull out the Prewire Harness.
- 2) Detach the Dummy Connector from the Gray 3P Connector on the Prewire Harness. (Return the Dummy Connector that you removed to the customer.)

#### ⚠ CAUTION

If you directly pull the Wire Harness without peeling off the Vinyl Tape (Pink), you risk damaging the Wire Harness.

Figure 14

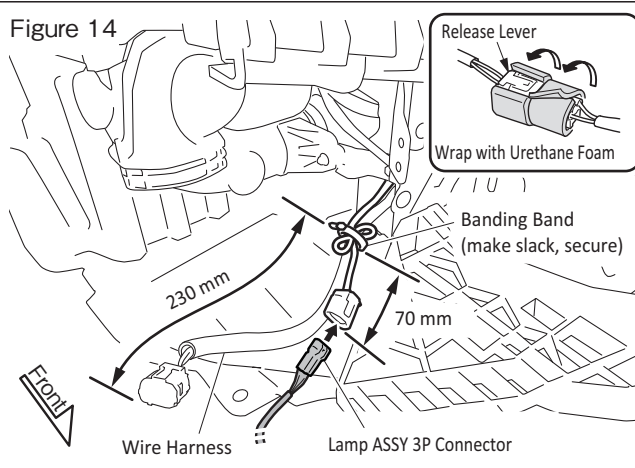

- 3) Bind some slack of the Prewire Harness and then secure the Prewire Harness to the Wire Harness using a banding band.
- 4) Connect the Lamp ASSY 3P connector to the Gray 3P Connector.

#### ⚠ CAUTION

Wrap Urethane Foam around the connector ensuring that you can see the Release Lever.

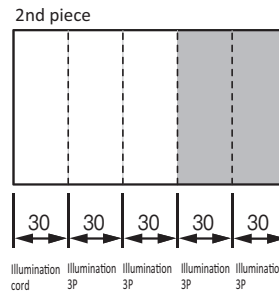
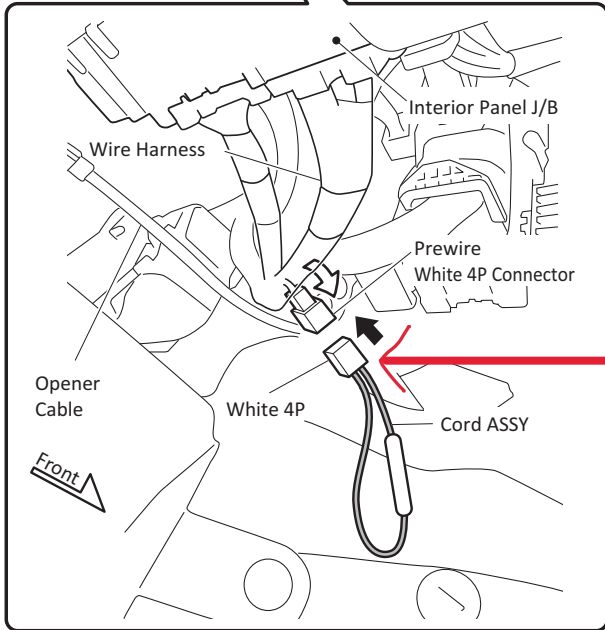
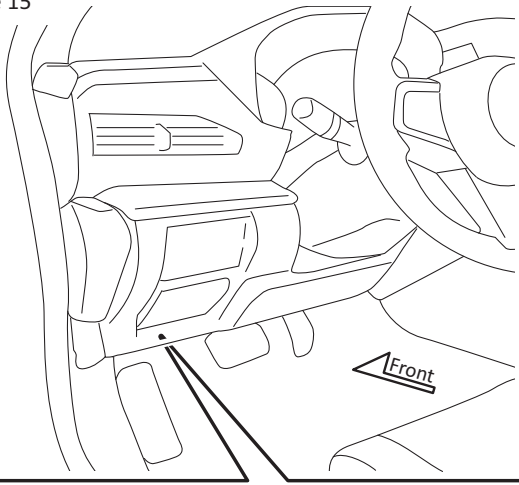

Figure 15



### Wiring Inside the Cabin

- 1) Connect the White 4P Connector (female) on the Cord ASSY to the Prewire Harness Connector (white 4P) near the back of the Interior Panel J/B.

Custom SMY Harness Included FREE when purchased from SMY

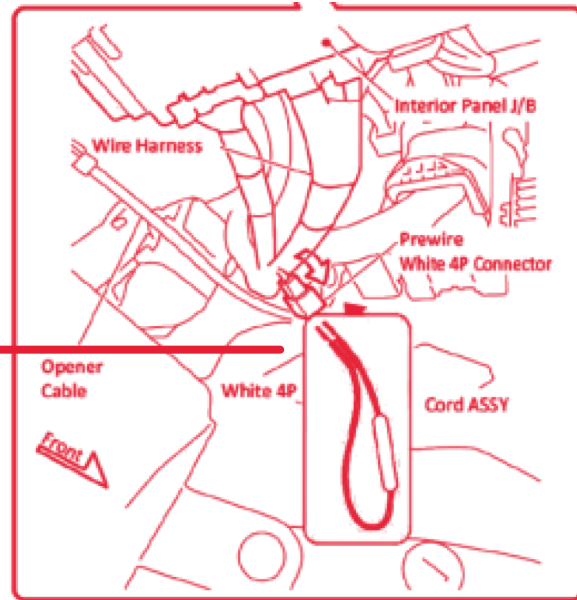
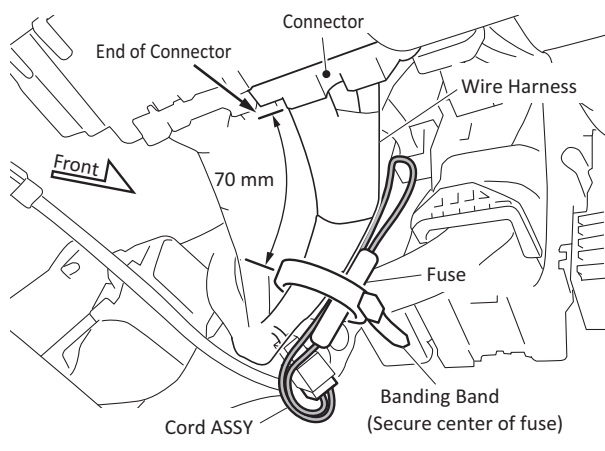

Figure 16



- 2) Secure the slack of the Cord ASSY to the Wire Harness using a Banding Band. (1 place)

#### ⚠ CAUTION

Secure the center of the fuse with a Banding Band.



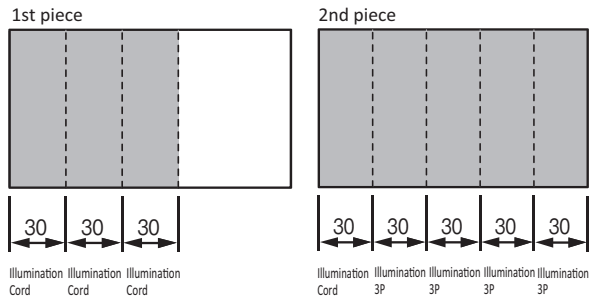

### How to Use the Urethane Foam (150 x 90 mm)

- 1) Cut the Urethane Foam in accordance with the amount to be used.  
The cut dimensions are shown on the left.

### 3.Installing Removed Parts

- (1) Install the parts that you removed in the opposite way to the removal procedure.

### 4.Checking Your Work

- (1) Temporarily connect the battery and put the gear selector position into parking.  
Press the "ENGINE START STOP" button twice without depressing the brake pedal to turn on IG. The LED Accessory Liner turns on and off by operating the switch on the switch ASSY. If the LED Accessory Liner does not function correctly, see "Troubleshooting" on the next page.
- (2) Fully tighten the minus terminal on the battery, and then check that the parts that you removed function. Set the audio, clock, and anything else that you made a note of, and then clean the vehicle. The procedure is now completed.

# Troubleshooting

## If the LED Accessory Liner does not function correctly

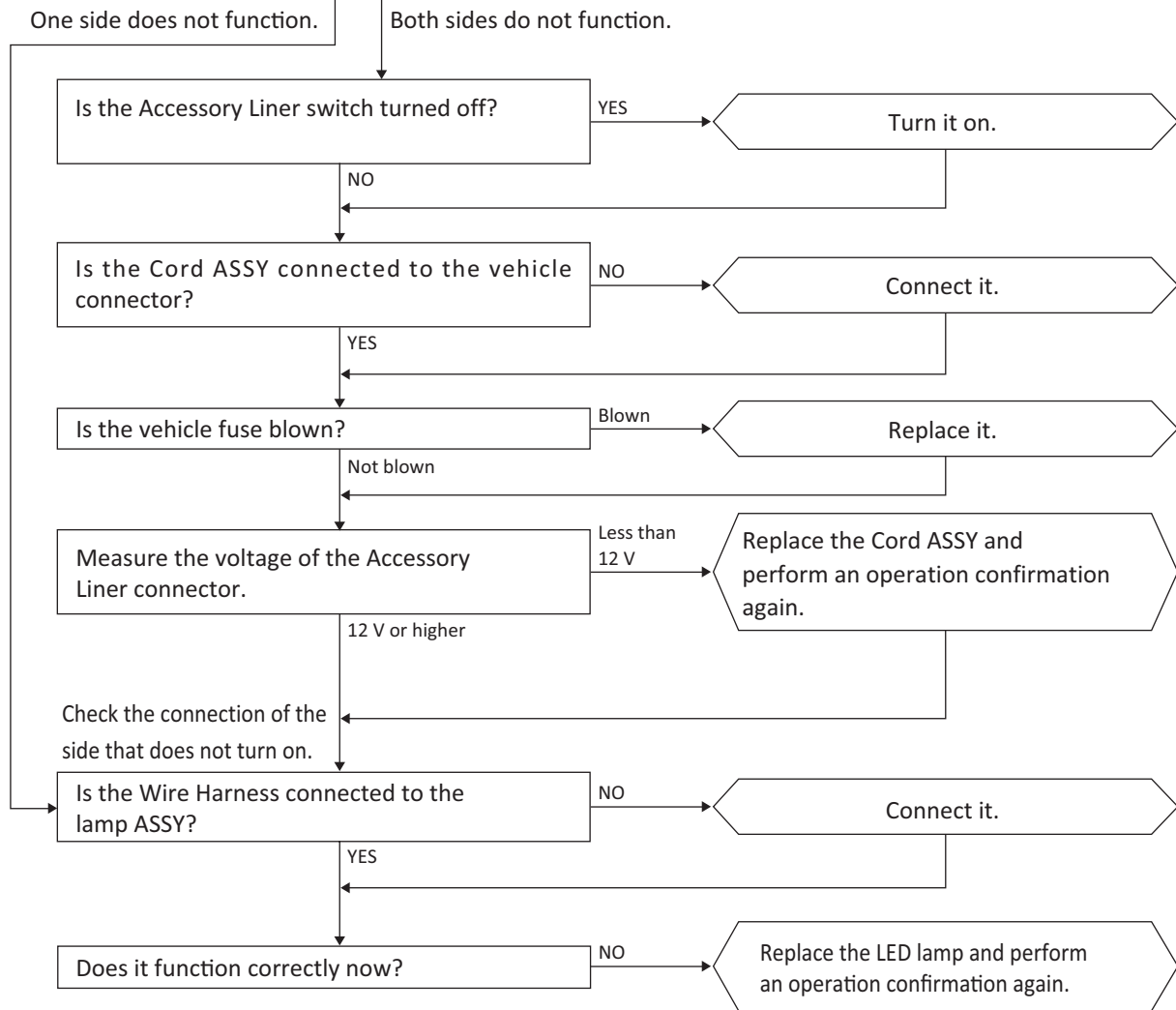

# Circuit Diagram

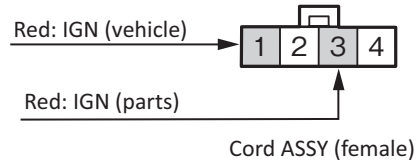
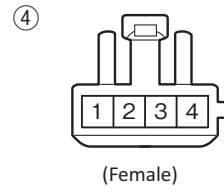
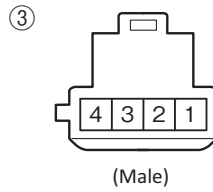
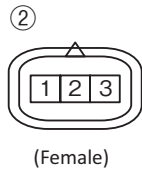
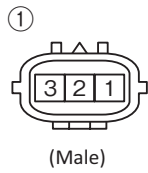
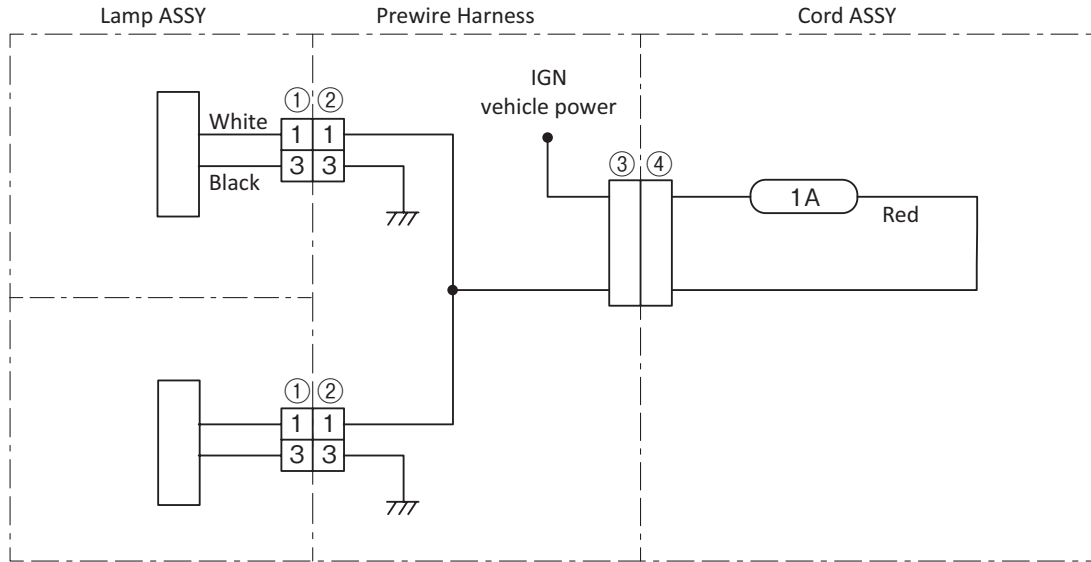

# Revision History

△	Description	Date