



Sport Grille

Installation Manual

Genuine Part Number: J1010VC120(WRX)

Applicable Model: WRX 2022MY~

Thank you for purchasing the Subaru Genuine Sport Grille.

This manual describes the procedure to install the Sport Grille on the WRX(VB) A TYPE.

Be sure to read this manual before installing this product and follow the instructions described below.

Component Parts

	No.	Part Name	Quantity
1	1	Sport Grille(WRX)	1
2	2	Camera Cover	1
3	3	Screw M4 x 12 mm	2

⚠ Installation Precautions

For your safety, important instructions that should be observed are shown with the following symbols in this Installation Manual.

- ⚠ CAUTION ...This refers to situations in which injury may occur or property may be damaged if the caution instructions are not followed.
- 👉 NOTE ...This denotes things that you should be made aware of so you can do the work quickly.

1. Park the vehicle on a level place, apply the parking brake, and use wheel chocks.
2. Make sure to arrange vehicle parts by part when removing them so that you do not lose the tapping screws, nuts and bolts, and so you do not mistaken them when reinstalling the vehicle components. Also, pay due attention not to damage the vehicle and the removed parts during work.
3. Follow the Owner's Manual when handling the battery.
4. To prevent damage to the vehicle and vehicle parts when removing vehicle parts and installing the product, be sure to perform the work on a Protective Sheet.

Installation of Parts

- Use proper size tools.
- Pay attention to the back side and do not allow any wire harness to get caught.



After Completion of Installation

- Be sure to reassemble all the vehicle parts that have been removed.

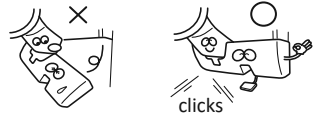

⚠ CAUTION

Follow the Service Manual when performing the work.

Tools Required

Combination Wrench (10 mm), Phillips-head Screwdriver, Flathead Screwdriver, Torque Screwdriver, Clip Remover, Protective Tape, and Blanket or Protective Sheet.

Post-installation Diagram

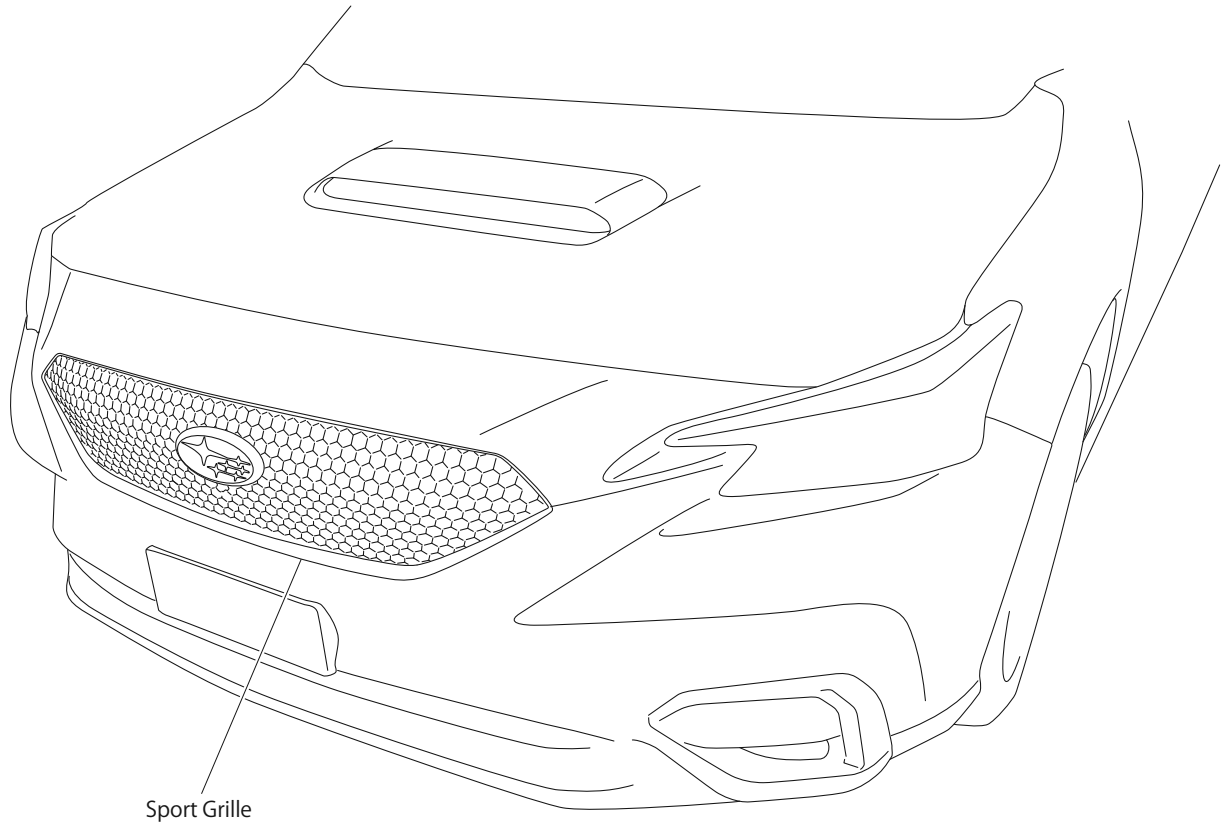

Installation Procedure

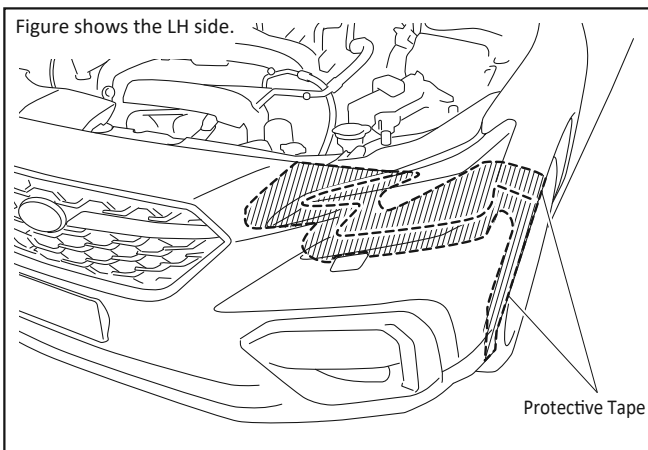

NOTE

For vehicles with Fog Lamps, disconnect negative battery terminal before starting.

1. Applying Protective Tape

- (1) Apply Protective Tape to the shaded area in the figure.
- (2) Repeat the same procedure for the right side.

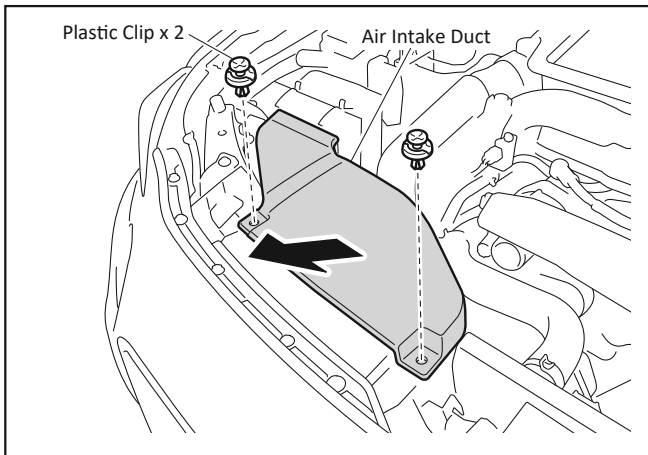

TG-ZR-A07

2. Removing the Air Intake Duct

<For vehicles with a camera>

- (1) Remove the Plastic Clips (2 pcs), and remove the Air Intake Duct by lifting it upwards.

⚠ CAUTION

Unless otherwise specified, the removed vehicle parts will be reused. Sort them out so that you do not lose any of the removed items.

(Adopt this practice throughout the rest of the procedure).

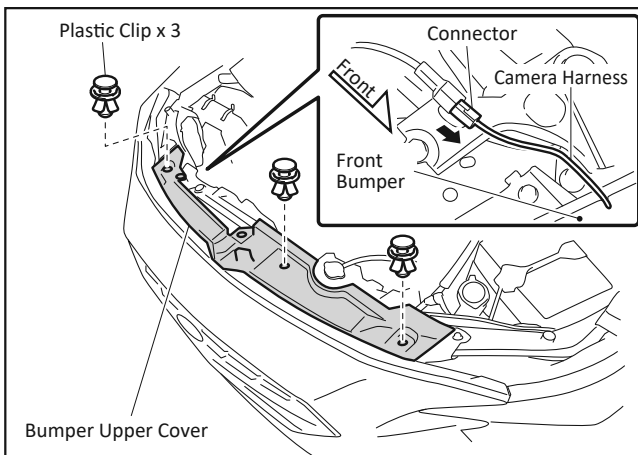

TG-ZR-A02

3. Removing the Bumper Upper Cover

<For vehicles with a camera>

- (1) Remove the Plastic Clips (3 pcs), and remove the Bumper Upper Cover.
- (2) Remove the camera harness connector.

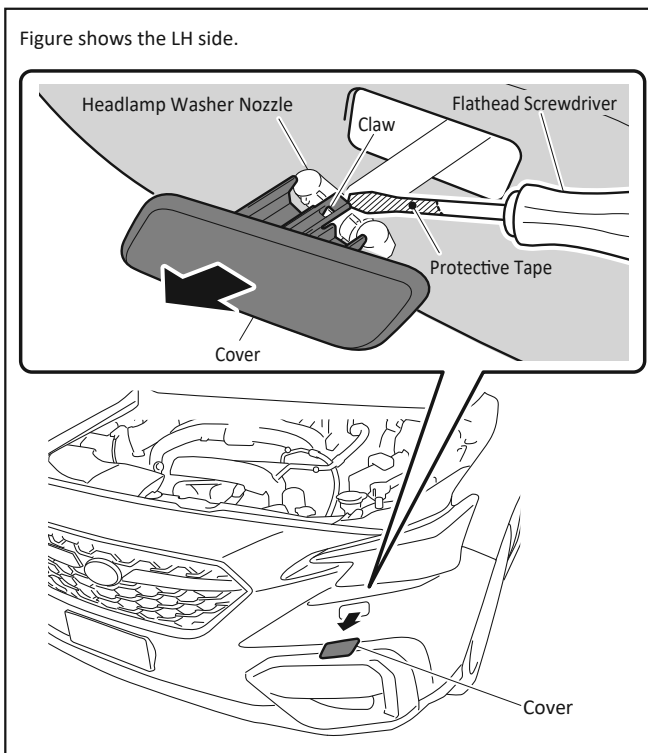

TG-ZR-A03

4. Removing the Headlamp Washer Cover

<For vehicles with Headlamp Washer>

- (1) Pull out the Headlamp Washer Nozzle, disengage the Claw, and remove the Cover.
- (2) Repeat the same procedure for the right side.

⚠ CAUTION

Unless otherwise specified, the removed vehicle parts will be reused. Sort them out so that you do not lose any of the removed items.

(Adopt this practice throughout the rest of the procedure).

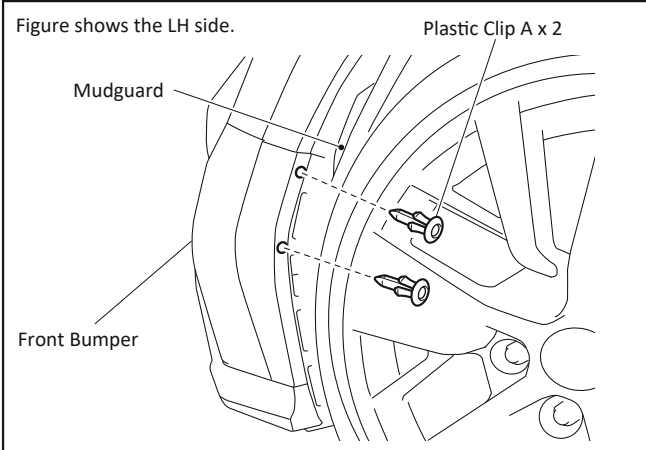

TG-YZ-A04

5. Removing the Front Bumper

- (1) Remove Plastic Clip A (2 pcs) that secure the Front Bumper.
- (2) Repeat the same procedure for the right side.

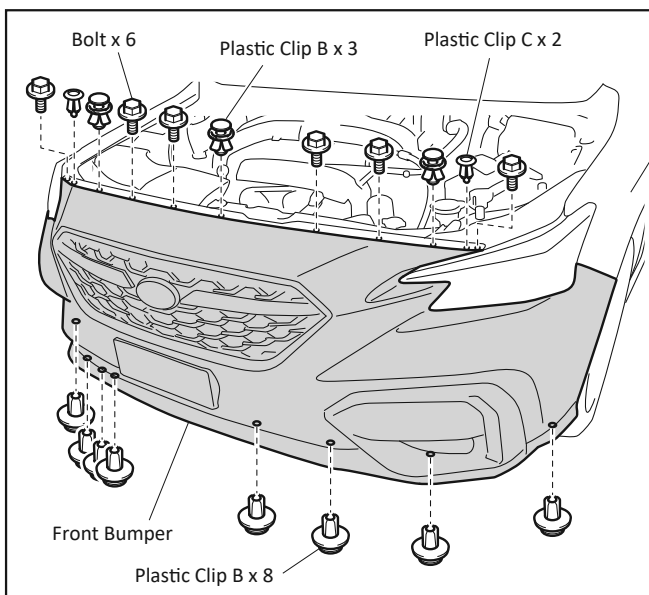

TG-ZR-A05

- (3) Remove the Bolts (6 pcs), Plastic Clip B (bottom: 8 pcs) (top: 3 pcs), and Plastic Clip C (2 pcs).

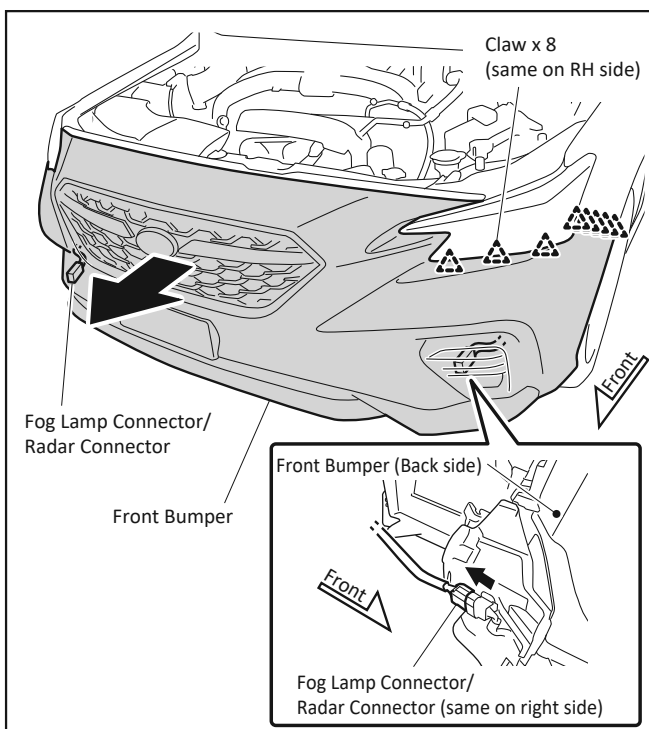

TG-ZR-A06

- (4) Disengage the Claws (16 places on right and left sides) and remove the Front Bumper, placing it at the front of the vehicle.

⚠ CAUTION

Be careful not to break the harness when removing the Front Bumper.

- (5) Disconnect the Fog Lamp Connector/Radar Connector and then remove the Front Bumper.

⚠ CAUTION

Place the Front Bumper on a Blanket or Protective Sheet so that it will not get scratched.

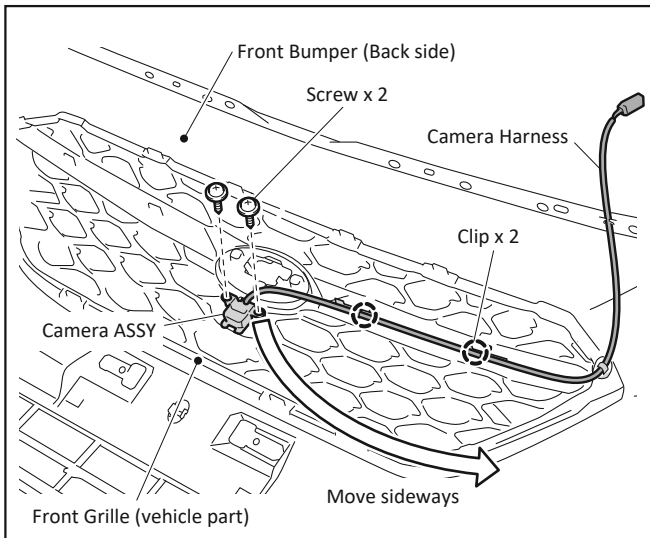

TG-ZR-B01

6. Detaching the Camera <For vehicles with a camera>

- (1) Remove the Screws (2 pcs).
- (2) Disengage the Clips (2 pcs), and detach the Camera from the Front Grille.

⚠ CAUTION

- (1) Be sure to remove and install the Front Bumper parts above a blanket or Protective Sheet so that they will not get scratched.
(Adopt this practice throughout the rest of the procedure).
- (2) Protect the Camera with a blanket or the like so that it does not get scratched.

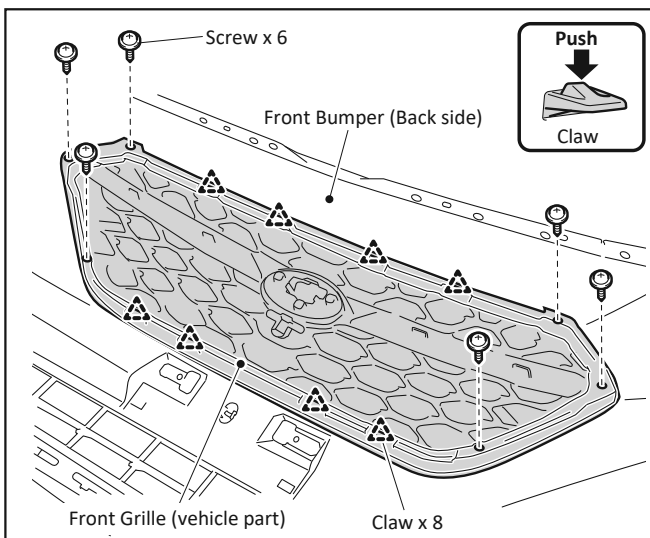

TG-ZR-B02

7. Removing the Front Grille

- (1) Remove the Screws (6 pcs).
- (2) Disengage the Claws (8 places) and remove the Front Grille (vehicle part).

⚠ CAUTION

- (1) Be sure to remove and install the Front Bumper parts above a blanket or Protective Sheet so that they will not get scratched.
(Adopt this practice throughout the rest of the procedure).
- (2) Protect the Camera with a blanket or the like so that it does not get scratched.

👉 NOTE

Front Grille (vehicle part) will not be used again.

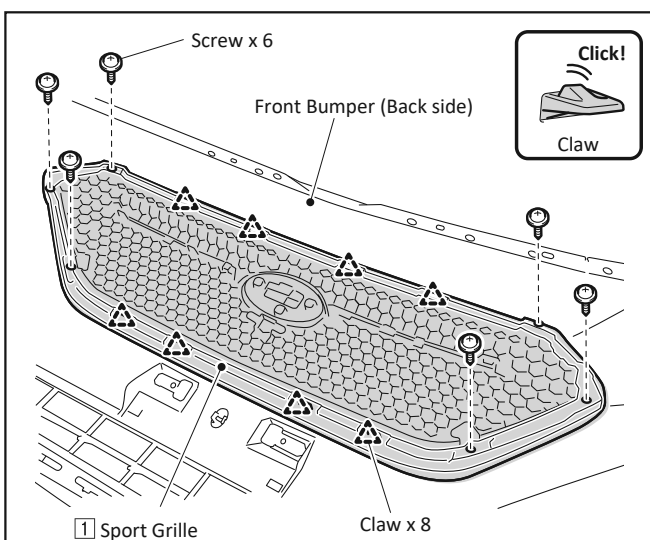

TG-ZR-B03

8. Installing the Sport Grille

- (1) Engage the Claws (8 places) to attach **1** Sport Grille to the Front Bumper.
- (2) Secure **1** Sport Grille with the Screws (6 pcs).

⚠ CAUTION

Tightening the Screws with an electric (high torque) tool may damage the grille so tighten the Screws by hand using a Phillips-head Screwdriver. (FYI: Tightening torque 1.5 N·m±0.3)

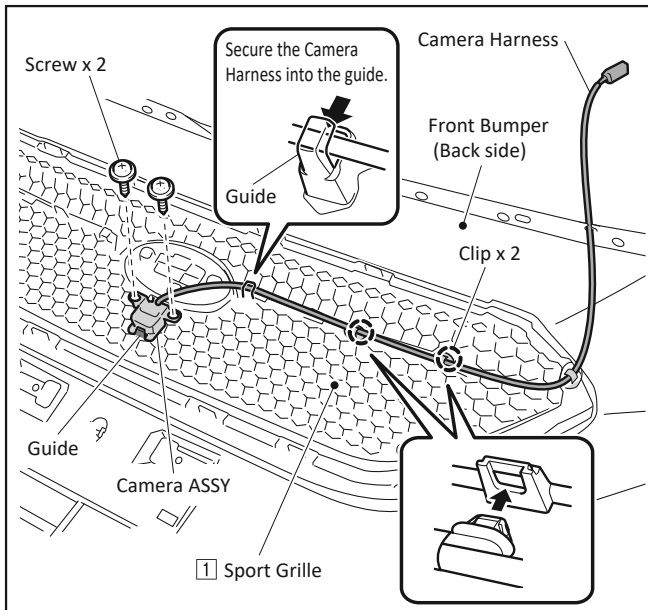

TG-ZR-B04

9. Installing the Camera

<For vehicles with a camera>

- (1) Attach the Camera ASSY to **1** Sport Grille with the Screws (2 pcs) and Guide (1 place).

Tightening torque: 1.1 Nm \pm 0.2

⚠ CAUTION

Do not use the M4 Screws (2 pcs) included with the product.

- (2) Engage the Clips (2 places) to secure the Camera Harness.

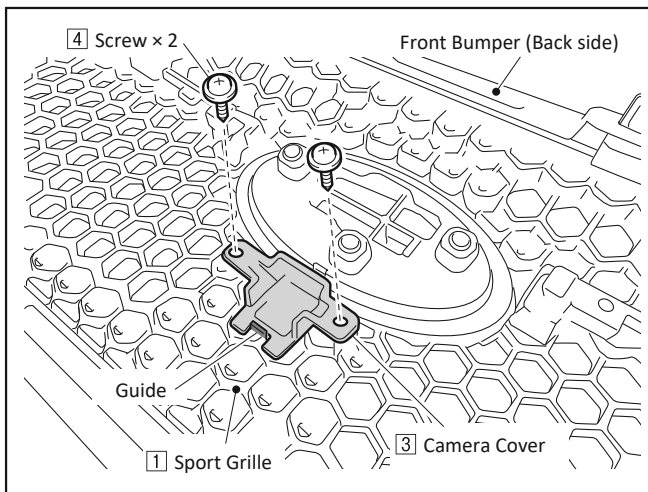

TG-ZR-B05

10. Installing the Camera Cover

<Only for vehicles without a camera>

- (1) Using **4** Screws (2 pcs) and Guide (1 place), attach **3** Camera Cover to **1** Sport Grille.

Tightening torque: 1.1 Nm \pm 0.2

⚠ CAUTION

Use the Screws (2 pcs) and Camera Cover included with the product.

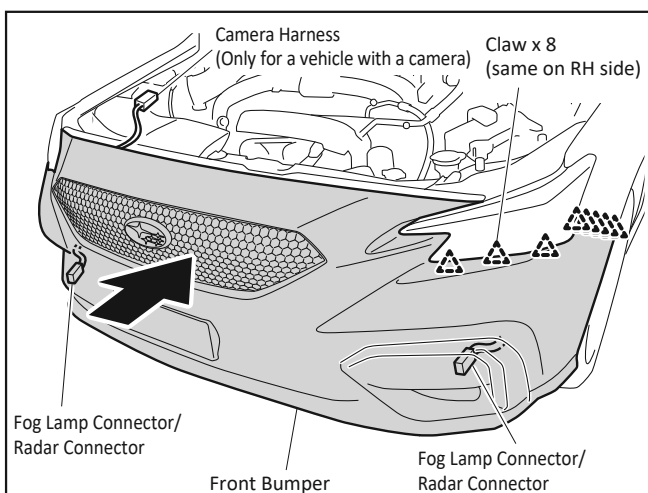

TG-ZR-C01

11. Reinstalling the Front Bumper

- (1) Place the Front Bumper at the front of the vehicle, and then connect the Fog Lamp Connector/Radar Connector.
- (2) Engage the Claws (16 places) and reinstall the Front Bumper.

⚠ CAUTION

(1) Check the orientation of the Fog Lamp Connector/Radar Connector and insert it until it makes a clicking sound. The Fog Lamps will not turn on if the connector is not connected correctly.

(2) Check that the Front Bumper Claws are set in the correct position before pushing them in to engage them. Not doing so may damage the Front Bumper.

(3) For vehicles with a camera, face the camera harness toward the engine room so that you will be able to connect it.

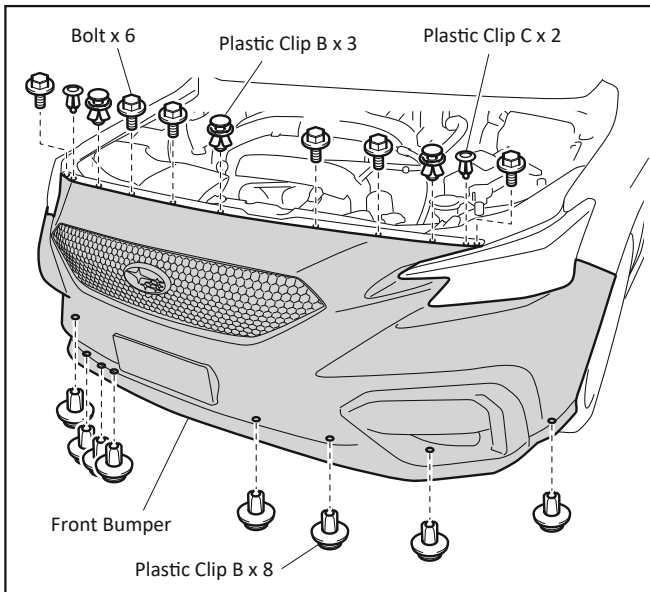

TG-ZR-C02

(3) Secure the Front Bumper with the Bolts (6 pcs), Plastic Clip B (bottom: 8 pcs) (top: 3 pcs), and Plastic Clip C (2 pcs).

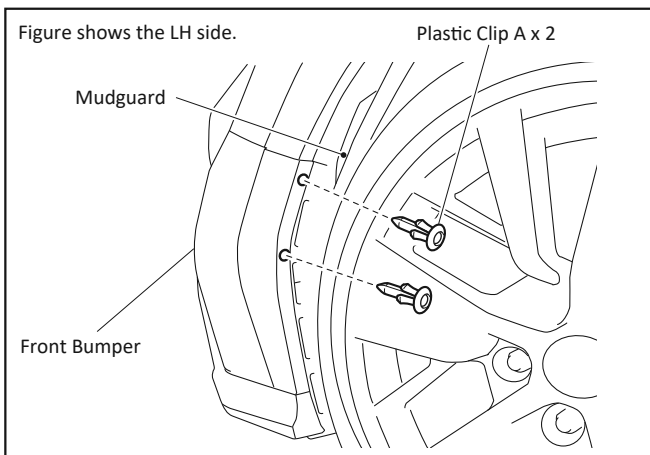

TG-ZR-C03

(4) Secure the Front Bumper with Plastic Clip A (2 pcs).

(5) Repeat the same procedure for the right side.

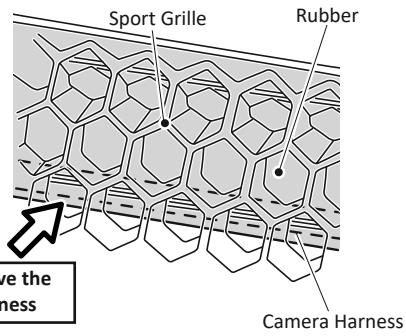

Rubber above the Camera Harness

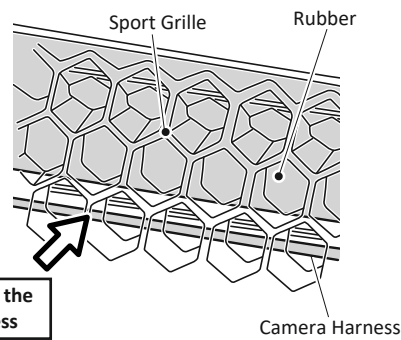
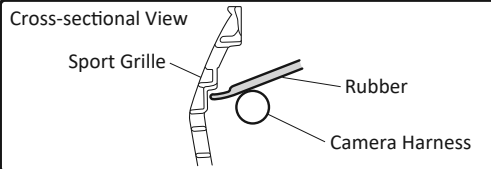

Rubber below the Camera Harness

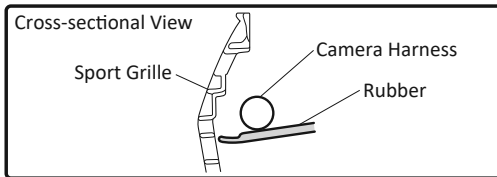

TG-ZR-C08

(6) After reinstalling the Front Bumper, check that the rubber is above the Camera Harness and does not protrude from the Sport Grille.

⚠ CAUTION

Adjust the rubber if it is not in the correct position. Fingers may be injured if they stick in the hole of Grille during the adjustment, therefore, use the Screwdriver with Protective Tape wrapped.

Figure shows the LH side.

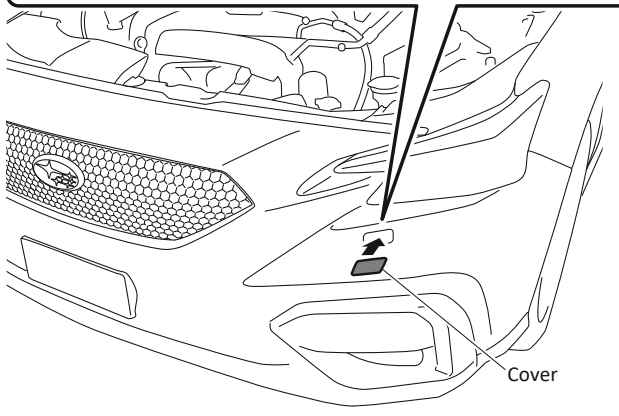
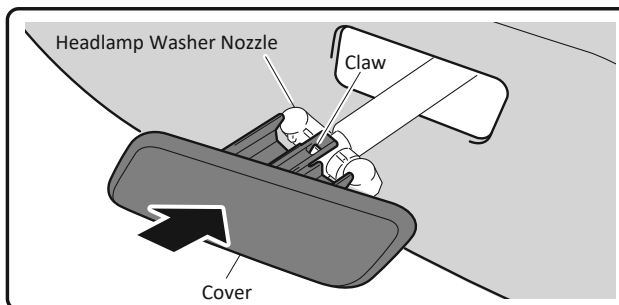

TG-ZR-C06

12. Reinstalling the Headlamp Washer Cover <For vehicles with Headlamp Washers>

- (1) With the Headlamp Washer Nozzle pulled out, engage the Claw to attach the cover.
- (2) Repeat the same procedure for the right side.

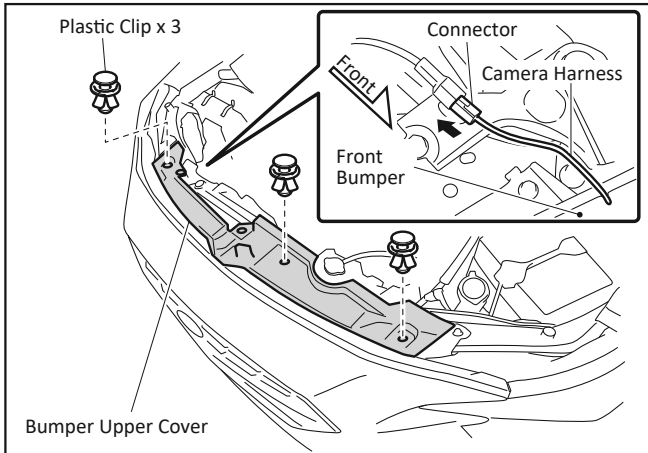

TG-ZR-C05

13. Reinstalling the Bumper Upper Cover <For vehicles with a camera>

- (1) Connect the camera harness connector.
- (2) Install the Bumper Upper Cover with the Plastic Clips (3 pcs).

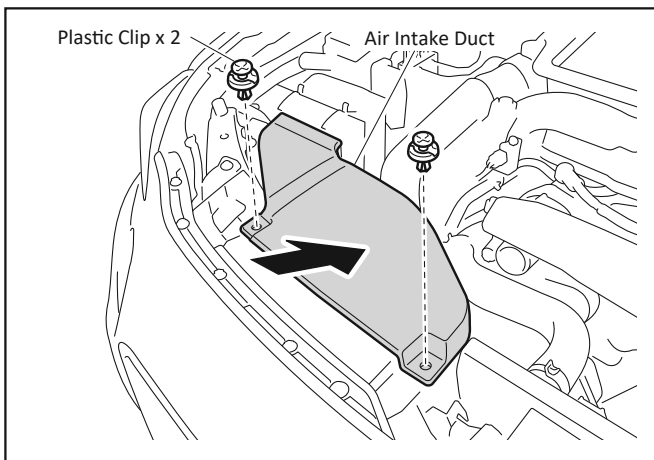

TG-ZR-C07

14. Reinstalling the Air Intake Duct <For vehicles with a camera>

- (1) Install the Air Intake Duct with the Plastic Clips (2 pcs).

Post-installation Inspection

- (1) Remove all Protective Tape.
- (2) Follow the Service Manual when performing the work.

Inspection Procedure

- (1) Check that the Fog Lamps turn on.
- (2) Check that the camera images are displayed correctly on the multifunction display.
- (3) Re-check that the Plastic Clips and Bolts are not loose, and the parts are properly secured, not scratched, or dirty.

Revision History

Revision	Revision Date	Revision details